

SHENZHEN TIBTRONIX TECHNOLOGY CO., LTD.



GSBL1G07D-53

1.25Gb/s 3Km LC BiDi SFP Transceiver
Hot Pluggable, Single LC, +3.3V, 1550nm Tx/1310nm Rx, FP-LD, Single-mode, DDM

2015/3/9



Shenzhen Tibtronix Technology Co., Ltd.

3/F, 12th Building, Nangang 1st Industrial Park, Baimang Xili, Songbai Road, Nanshan District, Shenzhen, China

Tel: +86 755 23316583

Fax: +86 755 29810056

E-mail: sales@tibtronix.com

<http://www.tibtronix.com>

Features:

- ✧ Up to 1.25Gb/s Data Links
- ✧ Hot-Pluggable
- ✧ Single LC connector
- ✧ Up to 3 km on 9/125µm SMF
- ✧ 1550nm FP laser transmitter
- ✧ 1310nm PIN photo-detector
- ✧ Single +3.3V Power Supply
- ✧ Monitoring Interface Compliant with SFF-8472
- ✧ Maximum Power <1W
- ✧ Industrial /Extended/ Commercial operating temperature range: -40°C to 85°C/-5°C to 85°C/-0°C to 70°C Version available
- ✧ RoHS compliant and Lead Free

Applications:

- ✧ 1000Base-LX Ethernet
- ✧ Metro/Access Networks
- ✧ 1×Fibre Channel
- ✧ Other Optical Links

Description:

TIBTRONIX's GSBL1G07D-53 Transceivers are a high performance, cost effective module which have a single LC optics interface. They are compatible with the Small Form Factor Pluggable Multi-Sourcing Agreement (MSA) and Digital diagnostics functions are available via the 2-wire serial bus specified in SFF-8472. The receiver section uses a PIN receiver and the transmitter uses a 1550 nm FP laser, up to 12dB link budge ensure this module 1000Base-LX Ethernet 3km application.

● Absolute Maximum Ratings

Parameter	Symbol	Min.	Typical	Max.	Unit
Storage Temperature	T_S	-40		+85	°C
Supply Voltage	V_{CC}	-0.5		4	V
Relative Humidity	RH	0		85	%

● Recommended Operating Environment:

Parameter	Symbol	Min.	Typical	Max.	Unit	
Case operating Temperature	T_C	Industrial	-40		85	°C
		Extended	-5		85	°C
		Commercial	0		+70	°C
Supply Voltage	V_{CC}	3.135		3.465	V	
Supply Current	I_{CC}			300	mA	
Inrush Current	I_{surge}			$I_{CC}+30$	mA	
Maximum Power	P_{max}			1	W	

● Electrical Characteristics($T_{OP} = -40$ to $85^{\circ}C$, $V_{CC} = 3.135$ to 3.465 Volts)

Parameter	Symbol	Min.	Typical	Max.	Unit	Note
Transmitter Section:						
Input differential impedance	R_{in}	90	100	110	?	?
Single ended data input swing	$V_{in\ pp}$	250		1200	mVp-p	
Transmit Disable Voltage	V_D	$V_{CC} - 1.3$		V_{CC}	V	2
Transmit Enable Voltage	V_{EN}	V_{EE}		$V_{EE} + 0.8$	V	
Transmit Disable Assert Time	$T_{dessert}$			10	us	
Receiver Section:						
Single ended data output swing	$V_{out,pp}$	300		800	mv	3
LOS Fault	$V_{losfault}$	$V_{CC} - 0.5$		V_{CC_host}	V	5
LOS Normal	$V_{los\ norm}$	V_{EE}		$V_{EE} + 0.5$	V	5
Power Supply Rejection	PSR	100			mVpp	6

Note:

1. AC coupled.
2. Or open circuit.

3. Into 100 ohm differential termination.
4. 20 – 80 %
5. LOS is LVTTTL. Logic 0 indicates normal operation; logic 1 indicates no signal detected.
6. All transceiver specifications are compliant with a power supply sinusoidal modulation of 20 Hz to 1.5MHz up to specified value applied through the power supply filtering network shown on page 23 of the Small Form-factor Pluggable (SFP) Transceiver Multi-Source Agreement (MSA), September 14, 2000.

● Optical Parameters($T_{OP} = -40$ to 85°C , $V_{CC} = 3.135$ to 3.465 Volts)

Parameter	Symbol	Min.	Typical	Max.	Unit	Note
Transmitter Section:						
Center Wavelength	λ_c	1530	1550	1570	nm	
Spectral Width(RMS)	σ_{RMS}			4	nm	
Optical Output Power	P_{out}	-9		-3	dBm	1
Extinction Ratio	ER	9			dB	
Optical Rise/Fall Time	t_r / t_f			260	ps	2
Relative Intensity Noise	RIN			-120	dB/Hz	
Total Jitter Contribution	TX Δ TJ			0.284	UI	3
Eye Mask for Optical Output	Compliant with IEEE802.3 z (class 1 laser safety)					
Receiver Section:						
Optical Input Wavelength	λ_c	1270	1310	1600	nm	
Receiver Overload	P_{ol}	-3			dBm	4
RX Sensitivity	Sen			-21	dBm	4
RX_LOS Assert	LOS _A	-35			dBm	
RX_LOS De-assert	LOS _D			-22	dBm	
RX_LOS Hysteresis	LOS _H	0.5			dB	
General Specifications:						
Data Rate	BR		1.25		Gb/s	
Bit Error Rate	BER			10^{-12}		
Max. Supported Link Length on 9/125 μm SMF@1.25Gb/s	L_{MAX}		3		km	
Total System Budget	LB	12			dB	

Note

1. The optical power is launched into SMF.
2. 20-80%.
3. Contributed total jitter is calculated from DJ and RJ measurements using $TJ = RJ + DJ$. Contributed RJ is calculated for 1×10^{-12} BER by multiplying the RMS jitter (measured on a single rise or fall edge) from the

oscilloscope by 14. Per FC-PI (Table 9 - SM jitter output, note 1), the actual contributed RJ is allowed to increase above its limit if the actual contributed DJ decreases below its limits, as long as the component output DJ and TJ remain within their specified FC-PI maximum limits with the worst case specified component jitter input.

4. Measured with PRBS 2^{7-1} at 10^{-12} BER

● Pin Assignment

Diagram of Host Board Connector Block Pin Numbers and Name

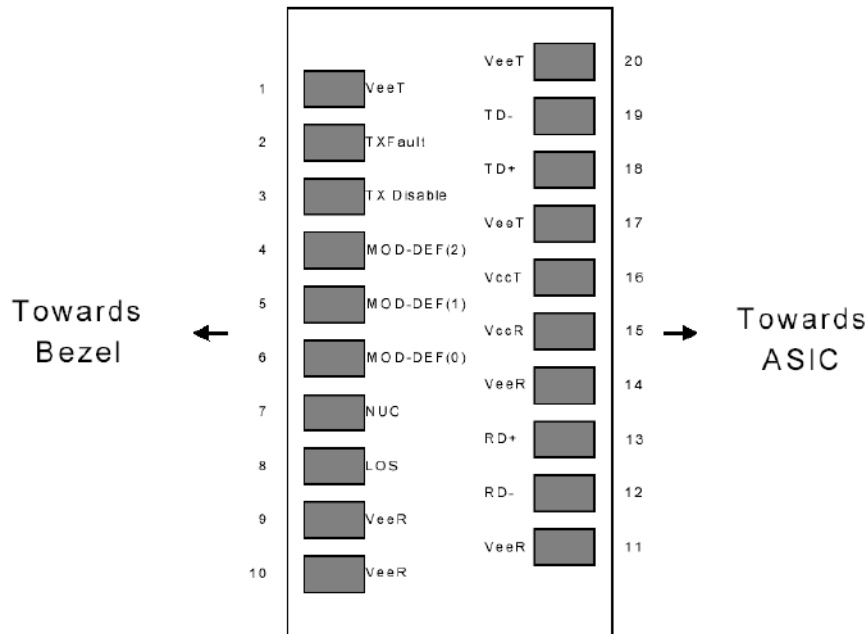

Diagram of Host Board Connector Block Pin Numbers and Names

● Pin Function Definitions

Pin No	Name	Function	Plug Seq	Notes
1	VeeT	Transmitter Ground	1	1
2	TX Fault	Transmitter Fault Indication	3	
3	TX Disable	Transmitter Disable	3	2
4	MOD-DEF2	Module Definition	2	3
5	MOD-DEF1	Module Definition 1	3	3
6	MOD-DEF0	Module Definition 0	3	3
7	Rate Select	Not Connected	3	4
8	LOS	Loss of Signal	3	5
9	VeeR	Receiver Ground	1	1
10	VeeR	Receiver Ground	1	1
11	VeeR	Receiver Ground		1
12	RD-	Inv. Received Data Out	3	6
13	RD+	Received Data Out	3	6

14	VeeR	Receiver Ground	3	1
15	VccR	Receiver Power	2	1
16	VccT	Transmitter Power	2	
17	VeeT	Transmitter Ground	1	
18	TD+	Transmit Data In	3	6
19	TD-	Inv. Transmit In	3	6
20	VeeT	Transmitter Ground	1	

Notes:

1. Circuit ground is internally isolated from chassis ground.
2. Laser output disabled on TDIS >2.0V or open, enabled on TDIS <0.8V.
3. Should be pulled up with 4.7k - 10 kohms on host board to a voltage between 2.0V and 3.6V. MOD_DEF(0) pulls line low to indicate module is plugged in.
4. Rate select is not used
5. LOS is open collector output. Should be pulled up with 4.7k – 10 kohms on host board to a voltage between 2.0V and 3.6V. Logic 0 indicates normal operation; logic 1 indicates loss of signal.
6. AC Coupled

● SFP Module EEPROM Information and Management

The SFP modules implement the 2-wire serial communication protocol as defined in the SFP -8472. The serial ID information of the SFP modules and Digital Diagnostic Monitor parameters can be accessed through the I²C interface at address A0h and A2h. The memory is mapped in Table 1. Detailed ID information (A0h) is listed in Table 2. And the DDM specification at address A2h. For more details of the memory map and byte definitions, please refer to the SFF-8472, “Digital Diagnostic Monitoring Interface for Optical Transceivers”. The DDM parameters have been internally calibrated.

Table 1. Digital Diagnostic Memory Map (Specific Data Field Descriptions)

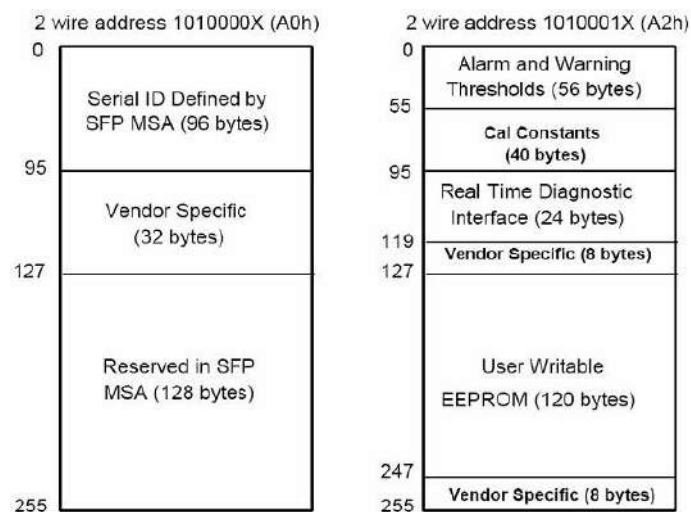

Table 2 - EEPROM Serial ID Memory Contents (A0h)

Data Address	Length (Byte)	Name of Length	Description and Contents
Base ID Fields			
0	1	Identifier	Type of Serial transceiver (03h=SFP)
1	1	Reserved	Extended identifier of type serial transceiver (04h)
2	1	Connector	Code of optical connector type (07=LC)
3-10	8	Transceiver	
11	1	Encoding	NRZ(03h)
12	1	BR, Nominal	Nominal baud rate, unit of 100Mbps
13-14	2	Reserved	(0000h)
15	1	Length(9um)	Link length supported for 9/125um fiber, units of 100m
16	1	Length(50um)	Link length supported for 50/125um fiber, units of 10m
17	1	Length(62.5um)	Link length supported for 62.5/125um fiber, units of 10m
18	1	Length(Copper)	Link length supported for copper, units of meters
19	1	Reserved	
20-35	16	Vendor Name	SFP vendor name: TIBTRONIX
36	1	Reserved	
37-39	3	Vendor OUI	SFP transceiver vendor OUI ID
40-55	16	Vendor PN	Part Number: "TSBL1G06-53" (ASCII)
56-59	4	Vendor rev	Revision level for part number
60-62	3	Reserved	
63	1	CCID	Least significant byte of sum of data in address 0-62
Extended ID Fields			
64-65	2	Option	Indicates which optical SFP signals are implemented (001Ah = LOS, TX_FAULT, TX_DISABLE all supported)
66	1	BR, max	Upper bit rate margin, units of %
67	1	BR, min	Lower bit rate margin, units of %
68-83	16	Vendor SN	Serial number (ASCII)
84-91	8	Date code	TIBTRONIX's Manufacturing date code
92-94	3	Reserved	
95	1	CCEX	Check code for the extended ID Fields (addresses 64 to 94)
Vendor Specific ID Fields			
96-127	32	Readable	TIBTRONIX specific date, read only
128-255	128	Reserved	Reserved for SFF-8079

● Digital Diagnostic Monitor Characteristics

Data Address	Parameter	Accuracy	Unit
96-97	Transceiver Internal Temperature	±3.0	°C
100-101	Laser Bias Current	±10	%
100-101	Tx Output Power	±3.0	dBm
100-101	Rx Input Power	±3.0	dBm
100-101	VCC3 Internal Supply Voltage	±3.0	%

● Regulatory Compliance

The GSBL1G07D-53 complies with international Electromagnetic Compatibility (EMC) and international safety requirements and standards (see details in Table following).

Electrostatic Discharge (ESD) to the Electrical Pins	MIL-STD-883E Method 3015.7	Class 1(>1000 V)
Electrostatic Discharge (ESD) to the Single LC Receptacle	IEC 61000-4-2 GR-1089-CORE	Compatible with standards
Electromagnetic Interference (EMI)	FCC Part 15 Class B EN55022 Class B (CISPR 22B) VCCI Class B	Compatible with standards
Laser Eye Safety	FDA 21CFR 1040.10 and 1040.11 EN60950, EN (IEC) 60825-1,2	Compatible with Class 1 laser product.

● Recommended Circuit

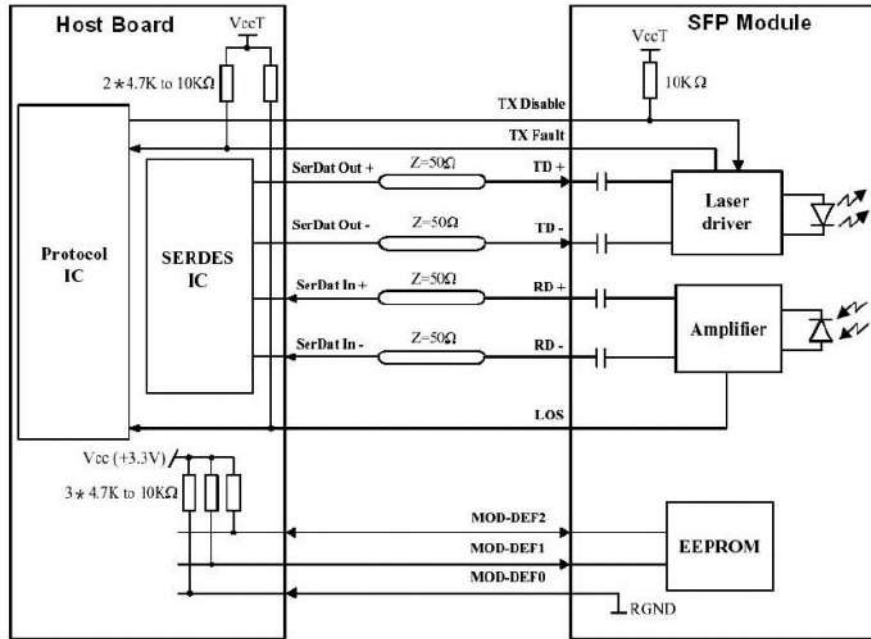

SFP Host Recommended Circuit

● Mechanical Dimensions

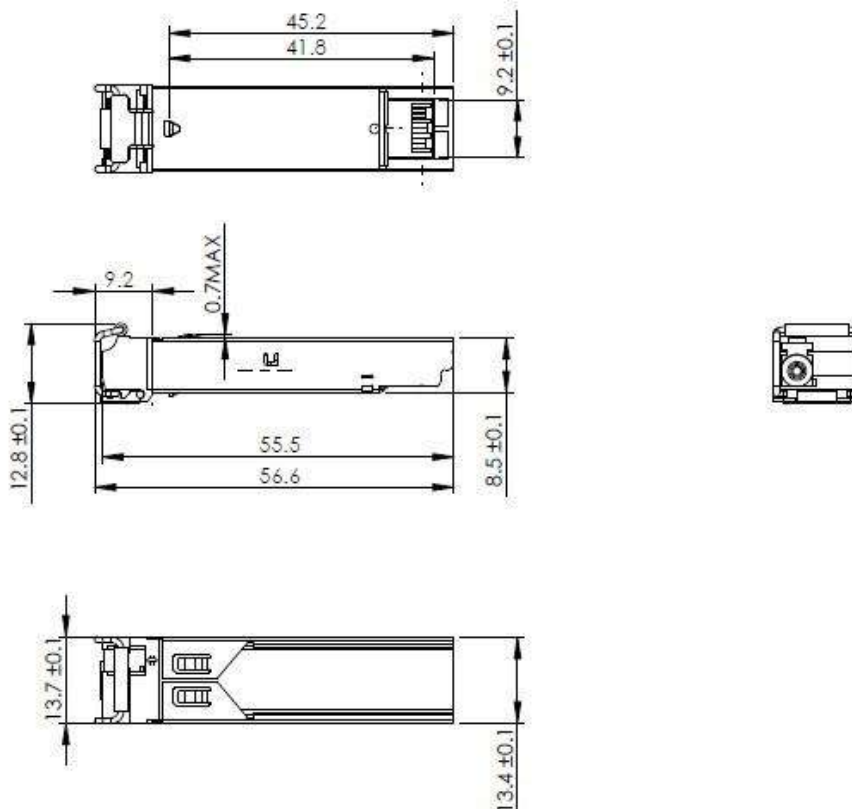

Mechanical Drawing

TIBTRONIX reserves the right to make changes to the products or information contained herein without notice. No liability is assumed as a result of their use or application. No rights under any patent accompany the sale of any such products or information.

Published by Shenzhen TIBTRONIX Technology Co., Ltd.

Copyright © TIBTRONIX

All Rights Reserved